

SMART VIDEO

DOOR PHONE INDOOR UNIT

Essential security solutions

Video door phones have become an integral part of our homes today. The security of our loved ones is the most important responsibility and video door phones help you with it. The audio visual conversation through the video door phone without even opening the door for anyone makes it safer.

SMART VIDEO

DOOR PHONE INDOOR UNIT

HI-RES COLOUR VIDEO DISPLAY
CRYSTAL CLEAR AUDIO
HANDS FREE FUNCTION
ULTRA FLAT DESIGN



OPERATION AND INSTALLATION
USER MANUAL



Scan and experience
new lifestyle products

From this moment on, you're going to experience a whole new world of good products for a better lifestyle. Look through the wide range of products and accessories and find yourself a good reason to switch to a better world.

GM Modular Pvt. Ltd. Te: 91-250-2451687/88 Fax: 91-250-2451689 info@gmmodular.com



INDEX

Warning and Caution	1
The function and name of each part	3
Features and main function	4
Package contents	5
System layout	5
Wiring diagram	6
Installation method	7
Cable specification	8
Incoming call answer	9
Monitor doorbells or CCTV cameras	9
Broadcast function	9
Internal call among monitors	10
Brightness/ colour/ contrast adjust	10
Talking volume adjust	10
Don't disturb function	10
Monitor listening	10
System main menu	11
Specification	12

Thank you for purchasing GM product. Hope you have carefully read this user's guide. Kindly follow the instructions before using the product for proper installation. The products are subject to change without prior notice.

SPECIFICATIONS

NO.	ITEMS	CONTENT
1.	Operation Power	AC 100V – 240V, 50-60Hz
2.	Power consumption	50mA (Max), 15mA (in standby)
3.	Operation temperature	0°C to +40°C
4.	Operation humidity	0% ~ 95%
5.	Display panel	7 inch
6.	Intercom function	Hands free
7.	Connection	4 wires
8.	Dimension	210mm X 116mm X 25mm
9.	Weight	450g

WARNING AND CAUTION

Make sure to follow the instructions to prevent any danger or property losses.



Warning

Death or serious injury is expected.



It indicates prohibition



It indicates disassembly.



It indicates prohibition of contact.



It indicates does and don'ts



It indicates that the plug should be pulled out from the socket.

Warning

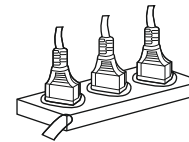

Do not put the plug in the socket simultaneously. It may generate abnormal heat or cause a fire.

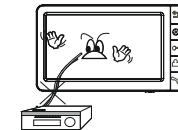

Do not connect to other products while in use. It may cause breakdown.

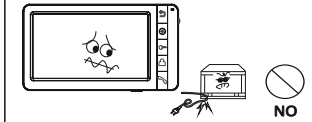

Do not forcibly bend the cord or put a heavy object on the product. It may cause a fire.

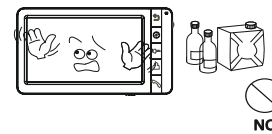

Do not use water, thinner or a detergent used to wash oil products when you wash the exterior. Make sure to wash it by using a dry cloth to prevent any breakdown or electric shock.

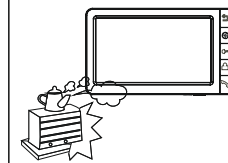

Do not install the product in a humid place. It may cause an electric shock or a fire.

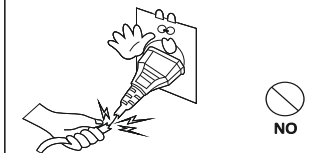

Do not forcibly pull out the cord from the socket. If the cord is damaged, it may cause a fire or an electric shock.

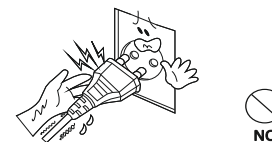

Do not put the plug in the socket with a wet hand. It may cause an electric shock.

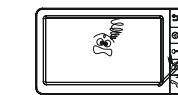

Do not disassemble, repair or modify the product. It may cause a fire, an electric shock or an injury due to malfunction of the product.

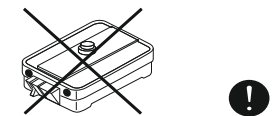





Do not use AC circuit breaker. It may cause an electric shock.

Make sure to follow the instructions to prevent any danger or property losses.



Caution

An injury or property losses are expected.

-  It indicates prohibition
-  It indicates disassembly.
-  It indicates prohibition of contact.
-  It indicates does and don'ts
-  It indicates that the plug should be pulled out from the socket.

Caution

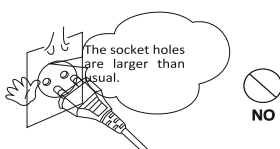

If the socket holes are larger than normal, do not put the plug. It may cause an electric shock or a fire.



Make sure that dust or foreign substances are not gathered on the product.



Make sure to prevent foreign substances from entering the product. It may cause a breakdown.

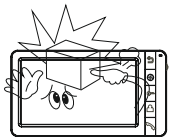

Do not put a heavy object on the product. It may cause a breakdown.

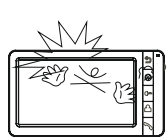

Do not disassemble or give an impact to the product.

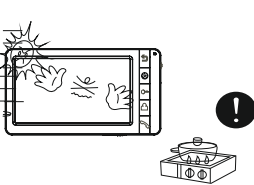

Avoid direct rays of the sun or heating devices at a time of installation.

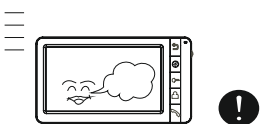

Install the product in a flat and stable place. Otherwise, it may not function properly.





Pull the plug if the product is not used for a long time.



If the product generates strange sound, make sure to pull the plug immediately and contact GM service center.

SYSTEM SETTING

In standby status, short-press  or the button on the right side to enter system.

NO.	SETTING ITEMS	OPTIONS	NOTE
1.	Language	Default English (Russian selectable)	
2.	Chime time	Default 30 seconds. (10~60 second adjustable)	
3.	Chime volume	Default 07,00~10 selectable	
4.	Record location	Door 1 ring type	00-11
		Door 2 ring type	00-11
		Door 3 ring type	00-11
5.	Do not disturb	The indoor monitor will be mute once someone presses doorbells / makes internal call / broadcast	
6.	Can be monitored		
7.	Device address	Room 1/2/3/4	The option will be yellow if two monitors set the same address.
8.	Port 4 state	None / cctv1 / cctv & 2	
9.	Monitor unlock	Press  icon to unlock	
10.	Restore default	Restore the system	

Note: Long press: Press for 2 seconds



TALKING VOLUME/ BRIGHTNESS/ COLOUR/ CONTRAST ADJUST

When screen is on, you may rotary the BRIGHT/CONT/COLOR control knob on the right side of the monitor to enter Brightness/Contrast/Color adjust screen, adjust the brightness/contrast/color as the user wants. Please refer to Page 2 to find the places of each knob.

“DON'T DISTURB” FUNCTION

You can use SYSTEM SETTINGS menu to turn DO NOT DISTURB on or off.

MONITOR LISTENING

At standby state, short press  button starts the monitor function. If you have more than 2 indoor monitors, click the target monitor NO. up or down toggle switch to choice, short press  to confirm.

Note:

a: During monitoring, monitoring part can hear the sound of be monitored, but be monitored part can not hear the monitoring part's voice. When screen is on, you may rotary the BRIGHT/CONT/COLOR control knob on the right side of the monitor to enter Brightness/Contrast/Color adjust screen, adjust the brightness/contrast/color as the user wants. Please refer to Page 2 to find the places of each knob.

b: When there are more than 2 monitors in the system, monitor listening is available only when Monitor listening function is turn on. Please check the system settings menu to see how to turn on the monitor listening.

THE FUNCTION AND NAME OF EACH PART

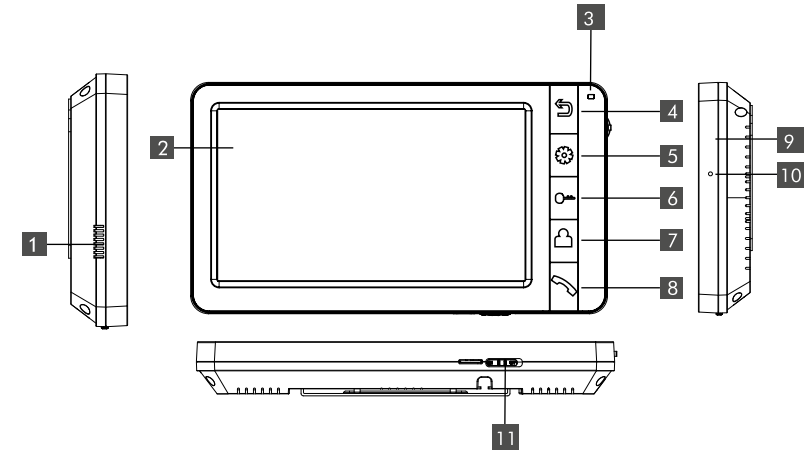

NO.	ITEMS	
1.	Speaker	
2.	Display screen	
3.	Indicator lamp	Power indicator light
4.	Return button	Back / hang up
5.	Menu button	Enter system menu
6.	Unlock button	Unlock
7.	Monitor button	Monitor
8.	Answer button	Answer Call
9.	Volume switch	Volume +/- / confirm setting
10.	Microphone	
11.	Power on / off	

FEATURES AND MAIN FUNCTION



1. Features

- 7" High-Definition LCD screen
- Hands free design with perfect intercom with clear voice
- Comfortable mechanical keys
- Multi – language user friendly interface
- 12 polyphonic ring-tones
- Easy to operate

2. Main function

- Hands – free video intercom
- Lock control
- Adjustable brightness, contrast, volume, colour and display mode.
- Real time monitoring of doorbell or CCTV camera
- "Do Not disturb" function
- Broadcasting, Intercom call monitoring





INCOMING CALL ANSWER

When a visitor presses doorbell, all the indoor monitors in this house will chime simultaneously, the screen will show INCOMING CALL. Click the button  to talk with the visitor. If you want to unlock the door for the visitor, click the  button, then DOOR UNLOCKED will show on the screen.

1.If there is another incoming call during conversation, SOMEONE IS VISITING button DOOR 2 will display, short click the  button can switch to another visiting.

2.You can transfer your call to any monitor in the system while talking to the visitor. If you want to transfer the call to others, click the  can transfer the call. At this time the other person can talk with the visitor.





MONITOR DOORBELLS/ CCTV CAMERA

At standby state, click  to enter system menu, then click the button  again, you can switch to other monitor channels. Click the button  you can view images from the connected doorbell/ CCTV. When the microphone is in normal operation, click the  button can open the door.

BROADCAST FUNCTION

This function allows you to broadcast information for all monitors in your house. At standby state, Long press , the display will show BROADCASTREQUEST; the monitor in other rooms will show BROADCASTING. Now you can make broadcast announcement.

INTERNAL CALL AMONG MONITORS

If you make intercom request for all monitors. At standby state, click  to call other indoor monitor. If you only have 2 monitors connected together, you can click up or down toggle switch to select call target, and click  to confirm call. Click  to answer the call, or click  to hang up screen to confirm that you want to talk with.

CABLE SPECIFICATION

Our system has 2 solutions to unlock the door: Unlock signal from doorbell or unlock signal from monitor. (The cable shield wire needs to be grounded) When signal from the doorbell, cable specification is:

- Distance between monitor and door station is less than 30 meters, shielded 4 x 0.5mm² cable is available.

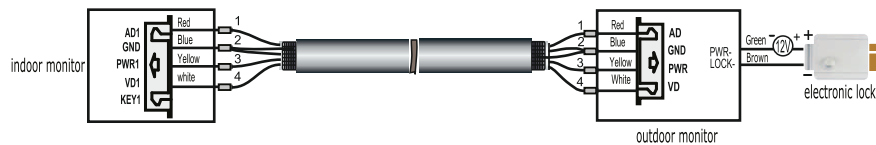

- Distance exceed 30 meters, please choose SYV-75-3 coaxial cable for video with another shielded 2 x 0.5m² cable or professional cable SYV – 75 – 3 + RVVP 2 x 0.5mm².

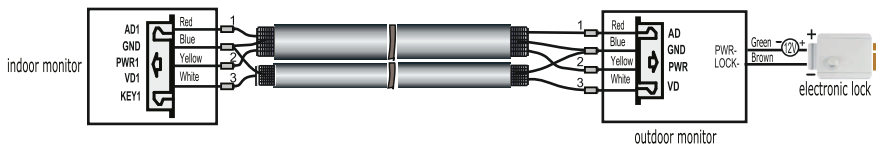

When signal is from monitor, cable specification is:

- Distance between monitor and door station is less than 30 meters, shielded 6 x 0.5mm² cable is available.

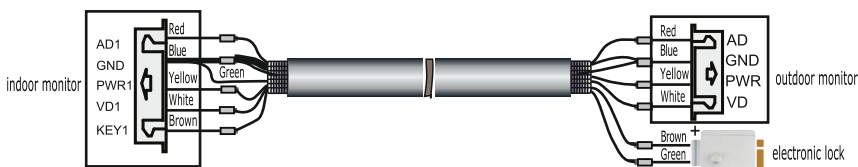

- Distance exceed 30 meters, please choose professional cable SYV – 75 – 3 + RVVP 4 x 0.5 mm² (recommended).

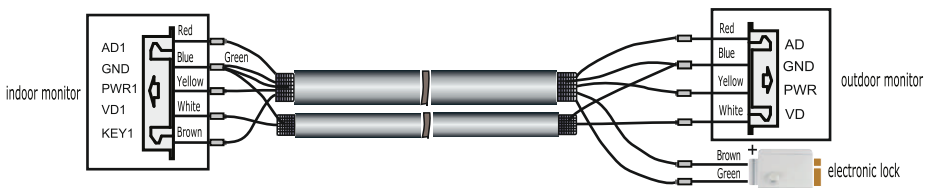

PACKAGE CONTENTS

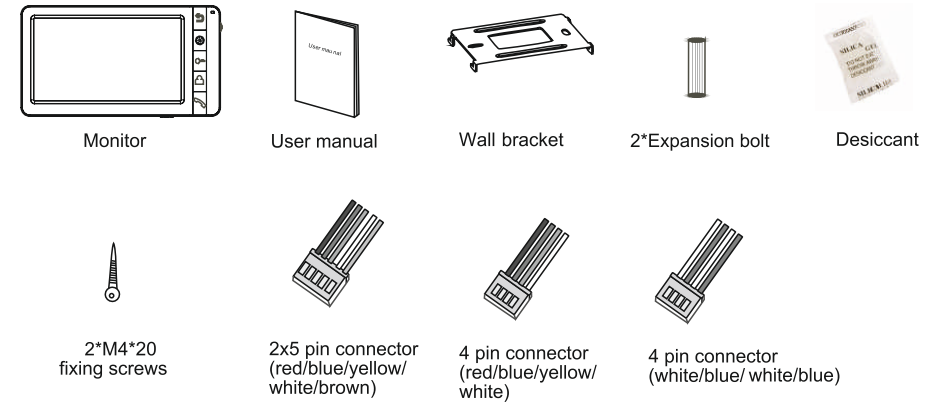

SYSTEM LAYOUT

THE PORT 2 CONNECT DOORBELL PANEL

The system can maximum support 1 main monitor, 3 sub monitors, 2 door panels and 8 CCTV cameras.

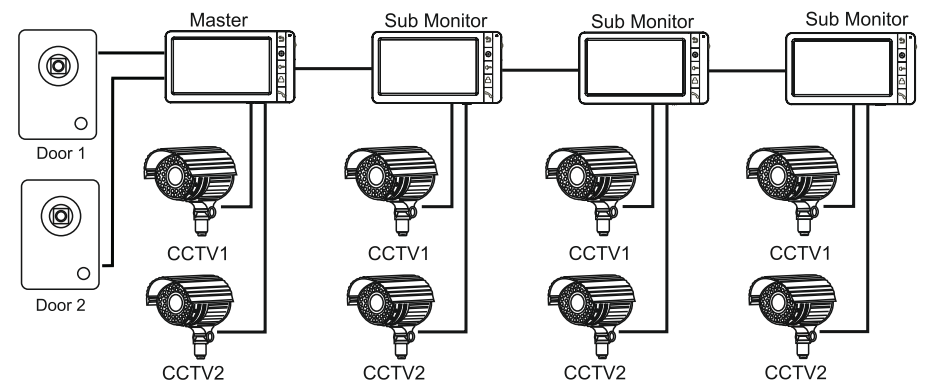

WIRING DIAGRAM

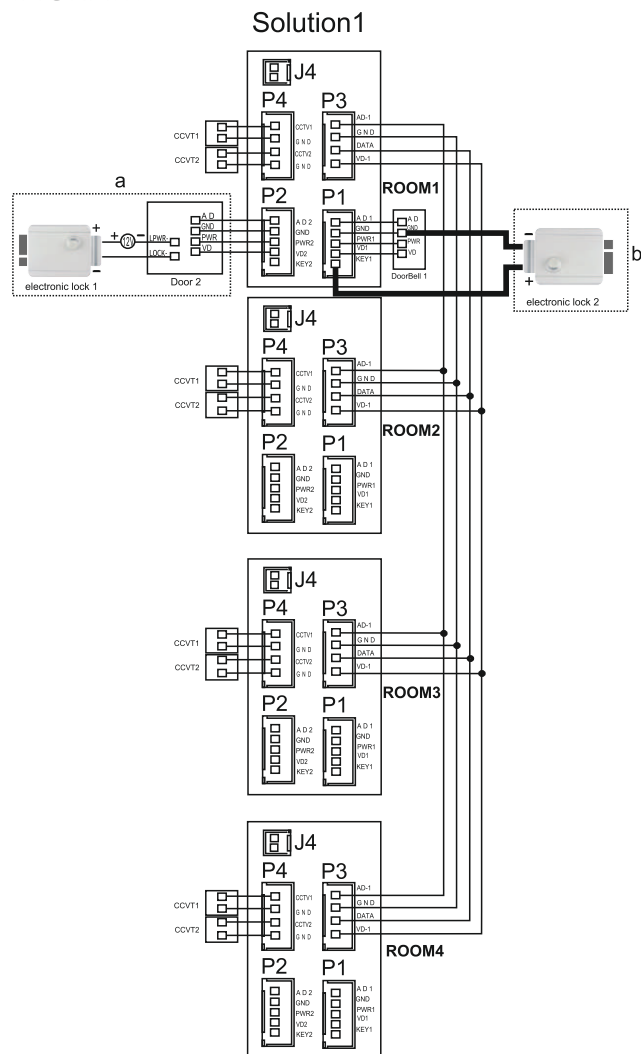

Note: (a) Door panel unlock wiring: electronic lock 1+ external power supply.
 (b) Indoor monitor unlock wiring: electronic 2+ bold black cable part.
 (c) J4 port for external power is optional.

INSTALLATION METHOD

1. Refer to relevant wiring diagram for the system you have chosen and ensure you have the correct cable.
2. Determine the monitor installation position:
 -Advised to install at 1.5 ~ 1.6 Meters;
3. Ensure no power supply connection before installation finished.
4. Install the bracket on the wall.
5. Connect cables as indicated in the wiring diagram.
6. Fix the monitor onto the bracket.
7. Connect power when doorbell is installed.

