

Operation And Installation

User Manual

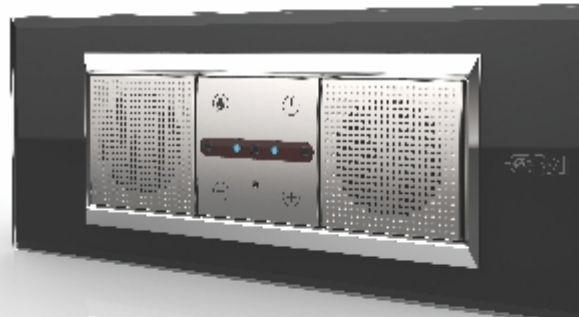

BLUPOD

Bluetooth Music Player with Voice Command



Scan and experience
new lifestyle products

GM Modular Pvt. Ltd.

Website www.gmmodular.com

Email info@gmmodular.com **Toll Free No.** 1800 209 1215



Congratulations

Thank you for purchasing the BLUPOD. Please read the instructions carefully to enjoy this smart product.

This guide contains helpful information that enables you to enjoy all of the features of your BLUPOD.

Index

Care and Maintenance -----	1
Features -----	2
Layout -----	3
Key Instructions -----	4
Wiring Diagram -----	5
Operations -----	6
LED Indicator -----	9
Troubleshooting -----	10
Specifications -----	11

Care and Maintenance

1. Do not attempt to service the product yourself. Opening or removing covers may expose you to dangerous voltages or other hazards, please contact your dealer.
2. Do not use the product in temperatures exceeding the standard. Extreme temperature will lead to the damage of product.
3. Keep the product out of the reach of children.
4. Do not drop the product into fire and water.
5. Use the product in proper volume, extremely high volume can be harmful for your ears.

Package Contents

BLUPOD Music Player (AA 2470)

Speakers (AA 2147) not included in the package.

Features

1. Crystal clear sound, superior stereo performance
2. Bluetooth Connectivity (Bluetooth V3.0)
3. Music playing control
4. Gestures Control
5. Voice Commands with (Siri* & S-Voice*)
6. Receiving and Ending a call by gestures and button
7. Bluetooth for 10m distance

Layout

Front View

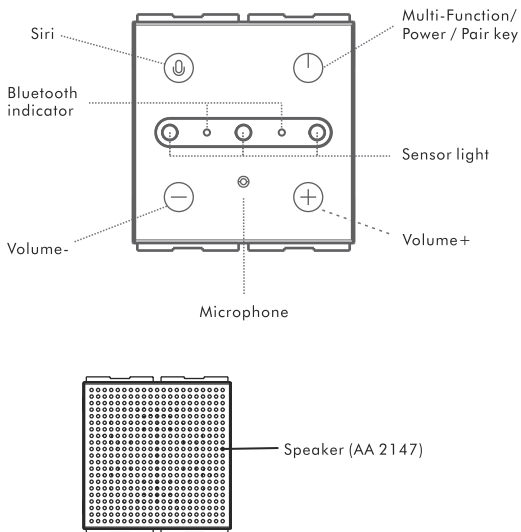

Key Instruction

Function Key	Item	Function	Operate
Multi-Function /Power key 	One Key	Power ON	Press & hold key 2 sec.
		Power OFF	Press & hold key 2 sec.
		Answer a call	Short press key
		End a call	Short press key
		Reject a call	Short press key twice
		Last number redial	Short press key twice
		Play	Short press key
		Pause	Short press key
Pair	Press & hold key 2 sec.		
Siri/S-Voice 	One Key	Siri/S-Voice	Short press key
Volume + (Vol+) 	One Key	Volume Up	Short press Vol
		Volume Up Rapidly	Press & hold Vol
Volume - (Vol-) 	One Key	Volume Down	Short press Vol
		Volume Down Rapidly	Press & hold Vol
Gesture		Previous Song	Wave right to left in the direction of the straight line
		Next Song	Wave left to right in the direction of the straight line
		Answer / End call	Wave left or right in the direction of the straight line

Wiring Diagram

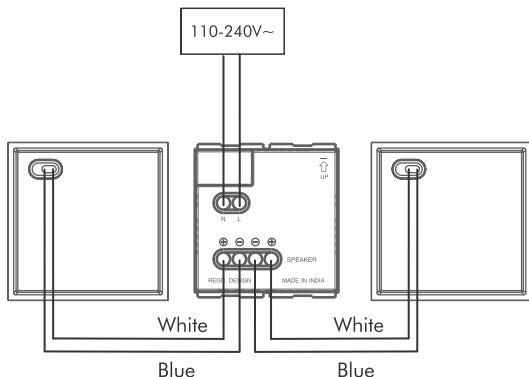

Operations

Power ON/OFF

Power ON: In power OFF mode, press and hold  for 2 seconds.

Power OFF: Press and hold  for 2 seconds.

Volume Adjust

Volume Up: Press  to adjust the volume.

Volume Up Rapidly: Press and hold  to adjust the volume.

Volume Down: Press  to adjust the volume.

Volume Down Rapidly: Press and hold  to adjust the volume.

Pairing and Connecting

Enter Pairing Mode

In standby mode, press and hold  key 2 seconds.

Pair

1. Enable Bluetooth function on your phone or other smart device and search Bluetooth accessories in range.
2. Choose **GM BLUETOOTH** when it shows up and connect.

Notes:

- If the pairing is not complete within 3 minutes, the BLUPOD will quit the pairing mode. You need to repeat the steps of pairing again.
- After the connection is successful, if you turn the BLUPOD off and turn it on again, it will be connected to the last connected device automatically.

Disconnect

Power OFF the BLUPOD or disconnect the Bluetooth function on your phone or other Bluetooth device.

Delete the paired device

Press and hold  12 seconds until Bluetooth LED flashes 3 times with the prompt of clearing pair.

Calling by Gesture and Button

Answer A Call

By Button : Short press  to answer an incoming call.

By Gesture : Wave hand left or right to answer an incoming call.

End A Call

By Button : After calling, short press  to end the call, or end the call on the phone.

By Gesture : Wave hand left or right to end a call.

Reject A Call

If a call is received, short press  twice to reject the call.

Last Number Redial

When connected, short press  twice to redial the last number.

Voice Command Calls (Siri*/S-Voice*)



Short press . This will access Siri*/S-Voice*.

Note:

- This function requires the support of the mobile device.

Operations (Continued)

Music Playing

After the BLUPOD is connected to your Bluetooth device, press  on the BLUPOD to play, press it again to pause. Press  or press  to adjust the volume.

Notes:

- A music player app is required on your device to support this feature.
- Pair and connect your Bluetooth device with the BLUPOD before using this feature.
- If a call is received when you are listening to music, the music will pause automatically and replaced by the incoming-call-tone. Press  to answer the incoming call. Once the call is finished, the music will continue.

Gesture

While playing music, wave left or right to select the desired track.

Notes:

- The distance between your hand and the BLUPOD should be less than 5 cm.

LED Indicator

Speaker Status	Red LED Status	Blue LED Status
Power ON	On steadily	Depend on the status of speaker
Power OFF	OFF	OFF
Pairing	On steadily	Flashes rapidly 3 minutes
Disconnected	On steadily	1s ON, 1s OFF
Connected	On steadily	Flashes twice every 2 seconds
Music Playing	On steadily	On steadily
During a Call	On steadily	On steadily

Troubleshooting

Volume is not High Enough

- Increase the volume of Bluetooth device or BLUPOD.
- Ensure that the Bluetooth device has been charged.
- Ensure that BLUPOD has been connected to power.

Hearing Distortion

- Lower the volume of BLUPOD or Bluetooth device slightly.
- Ensure that the Bluetooth device has been charged.
- Ensure that BLUPOD has been connected to power.

Cannot Pair with Bluetooth Device

- Make sure that your device is compatible with Bluetooth.
- Turn OFF your BLUPOD and Bluetooth device, then power ON and reconnect.

Signal Loss or Distortion

- Move BLUPOD closer to the Bluetooth device.
- Ensure it's charged.
- Turn OFF your BLUPOD and Bluetooth device, then power ON and reconnect.

Specifications

Bluetooth Compliance	Bluetooth V 3.0
Frequency Band	2.4~2.4835GHz ISM Spectrum
Modulation	GFSK (Gaussian Frequency Shift Keying)
Operating Range	Up to 10m (indoor)
Power Supply	110-240V~
Compatibility	Mobile phone/device supporting Bluetooth V1.1 (and above)
Size	48mm x 45mm x 56mm
Ambient Temperature	-20°C ~ 60°C
Humidity	45% ~70%

* iPhone, Siri® are registered trademarks of Apple Inc.

* S-Voice* are registered trademarks of Samsung.

- Design and specifications are subject to change without notice.
- BLUPOD music player can be connected with GM SOUND PLUS SPEAKERS