



SWITCH TO A BETTER WORLD



SWITCH TO A BETTER WORLD



www.gmmodular.com



From this moment on, you're going to experience a whole new world of good products for a better lifestyle. Look through the wide range of products and accessories and find yourself a good reason to switch to a better world.

Scan and experience new lifestyle products

## GCONNECT 2.5"

### INSTALLATION MANUAL

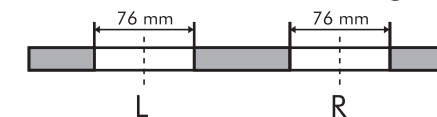
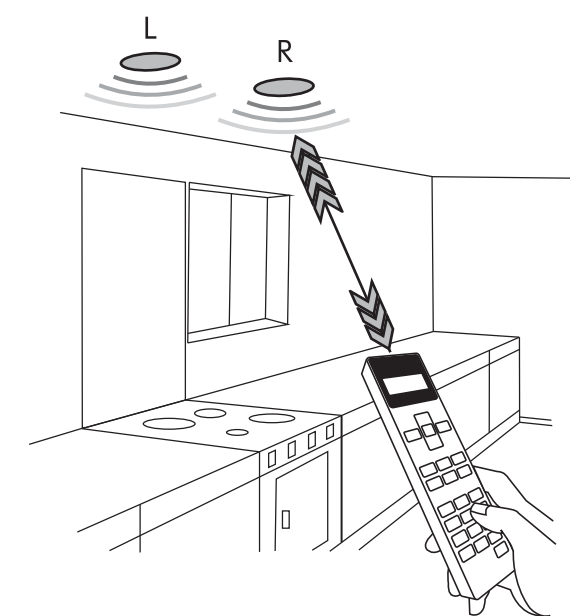
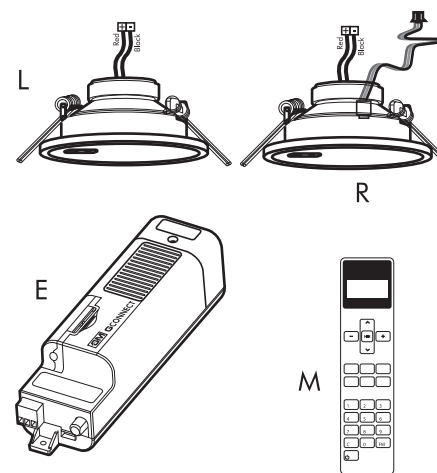

**1** Warning: More than one GCONNECT kits cannot be installed in the same room.

The components included in the GCONNECT kit are as follows:

- E Electronic module
- M Remote control
- L 2.5"/ 16 ohms loudspeakers
- R 2.5"/ 16 ohms loudspeakers + IR

#### CONNECTING TERMINALS

F	Power supply 230V
N	
L	Left Loudspeaker (red terminal /+)
R	Right Loudspeaker (red terminal /+)
C	Audio mass (black terminals -/)
IR	Infrared receiver with remote control connector
ANT	Antenna signal

**2**

#### Drill

Drill two 76mm. Diameter holes in the surface where the loudspeakers R and L and the electronic module E are to be installed. Note that, in order to receive the infrared signal from the remote control, loudspeaker R should be located in a visible spot that is not hindered by any obstacles. The minimum distance recommended between the electronic module E and any source of water or humidity is 2 meters. It is not recommended that the electronic module E be enclosed in a location without proper ventilation.

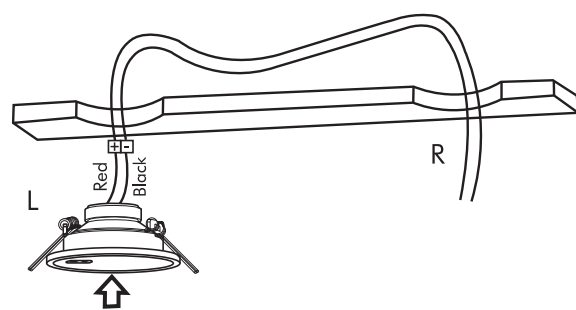

**3** Insert loudspeaker L and pull the joining cables to the other loudspeakers R's location.

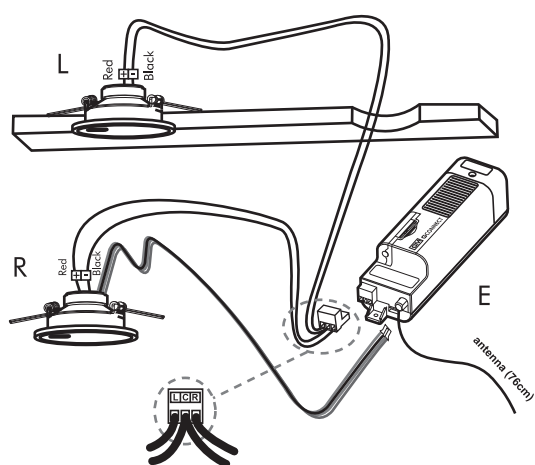

**4** Connect loudspeakers R and L to connecting terminals L, C and R on the electronic module E.

**5** Connect loudspeakers R's IR receiver cable to terminals IR on the electronic module E.

**6** Connect a 76 cm. wire to antenna terminal ANT on the electronic module E. A 75 ohm antenna signal can be connected to terminal ANT of the electronic module if FM reception is unsatisfactory.

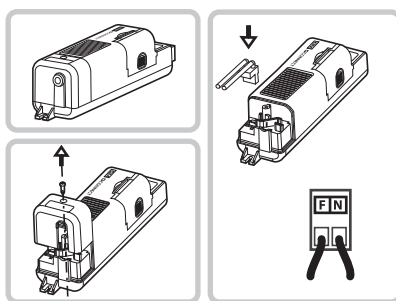

**7**

Connect to the electrical mains. The disconnecting device must be easily accessible at all times.

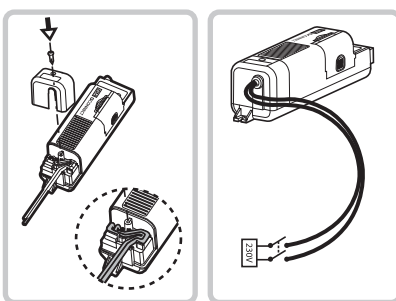

WARNING: MAKE SURE THERE IS NO VOLTAGE IN THE WIRES BEING HANDLED.

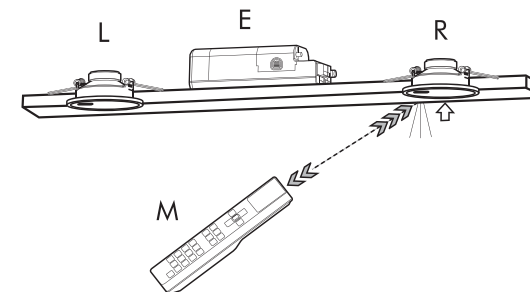
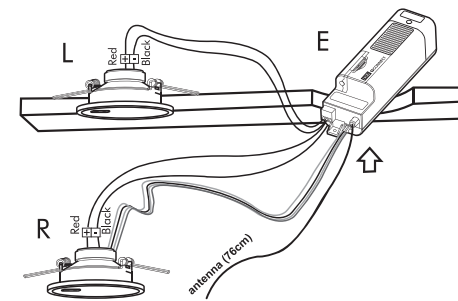

**8** Insert the electronic module E through the cavity prepared for loudspeaker R. Make sure the antenna cable is not near to possible noise sources such as fluorescent bulbs, power supplies, halogen lamps, fans, motors, etc. which could hamper the radio station reception and affect sound quality.

**9** Insert loudspeaker R in its final location.

**10 Start-up**  
Power-up the installation. The LED on the IR receiver will flash several times to indicate that the device has been switched on correctly. At that time, the GCONNECT unit is ready to be operated by the remote control unit M.

No part of this Installation Manual may be printed or duplicated without the consent of GM Modular Pvt Ltd. Patent TM & designs protected. Infringement is liable for prosecution. Imitation of graphics is a punishable offence.

GM reserves the right to make changes without prior notice.

For any queries please write to: info@gmmodular.com